

Push-In Terminal Block

Features

- Space-saving design
- Vibration proof anti-loosening wire connection with pre-stressed spring clamp
- Easy to operate, fast wiring installation with top wire entry
- Easy mounting and dismounting from the terminal rail
- Corrosion-proof terminal points
- Low contact resistance
- Easy for the extension of terminal connection
- Easy handling and safe connection
- Connecting without tools
- Colored plates ensure safety connections and operations

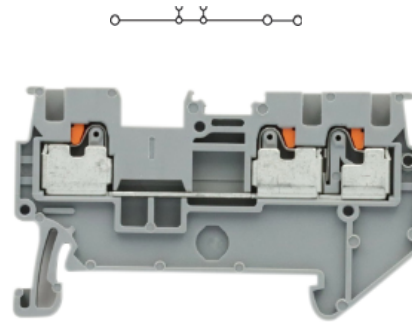

Specification

Rated Current & Voltage	15 A, 300 V (UL B,C Class) 5 A, 600 V (UL D Class) 17.5 A, 500 V (IEC)
Wire Size	26 ... 14 AWG, 0.14 ... 1.5 mm ²
Impulse Withstand Voltage / Pollution Degree	6 kV / 3
Insulation Stripping Length	8 ... 10 mm
Number of Positions	3
Operating Temperature	-40 ... 105 °C
Terminal Block Colour	Grey
Wire Connection Method	Push-In

Drawing

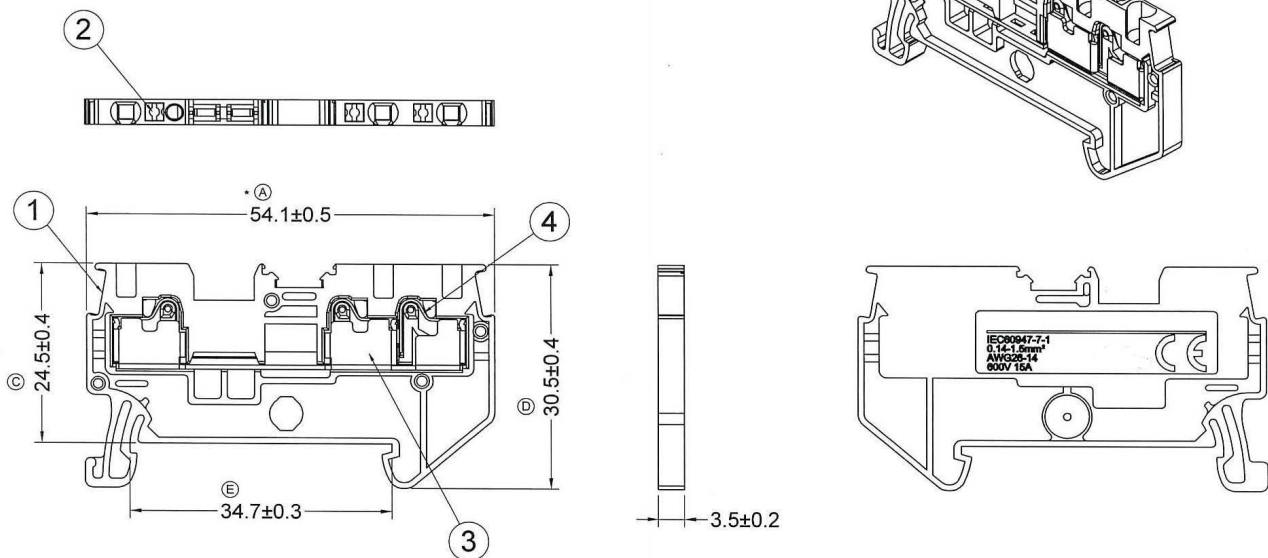

Material Specification

1 - Insulating Body	Polyamide 66
2 - Button	PBT
3 - Terminal	Copper, Tin Plated
4 - Spring	Stainless

Push-In Terminal Block

Accessories



End Plate
RND 205-01390

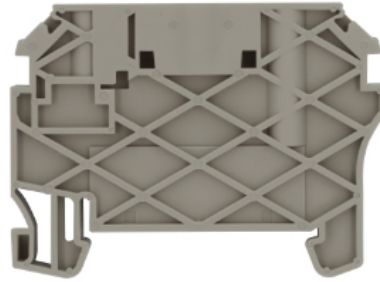

End Bracket
RND 205-01394

Art Nr.
RND 205-01380